

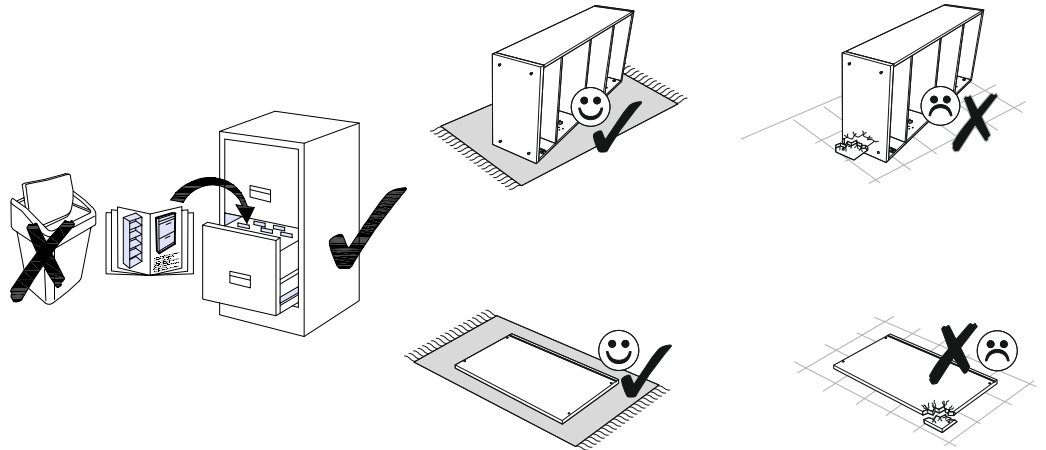







Ø8

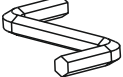

| | | | |
|---|--|--|--|
| j42  μ8 mm x4 | g22  x12 | j15  φ6x20 mm x12 | z1  x1 |
|---|--|--|--|

| | | | | |
|----------|---|--|---|---|
| 1 | j42 | g22 | j15 | z1 |
| |  μ8 mm x4 |  x12 |  φ6x20 mm x12 |  x1 |

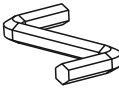